



# Installation instructions, accessories

Volvo Car Corporation Gothenburg, Sweden

Instruction No	Version	Part. No.
31659257	1.0	31659255

## Protective grille, steel



# Installation instructions, accessories

Volvo Car Corporation Gothenburg, Sweden

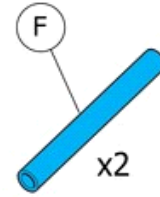
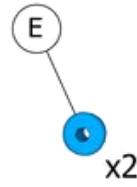
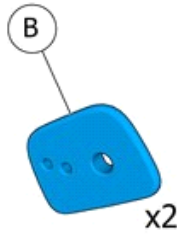
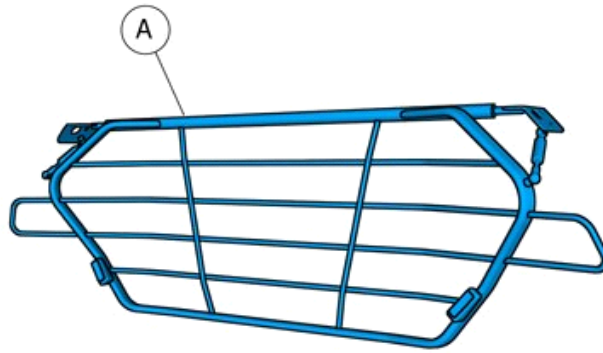

IMG-424109



# Installation instructions, accessories

Volvo Car Corporation Gothenburg, Sweden

---

## Information

1

Read through all of the instructions before starting installation.

Notifications and warning texts are for your safety and to minimise the risk of something breaking during installation.

Ensure that all tools stated in the instructions are available before starting installation.

Certain steps in the instructions are only presented in the form of images. Explanatory text is also given for more complicated steps.

In the event of any problems with the instructions or the accessory, contact your local Volvo dealer.

---

## Further information

2



IMG-400004

**Warning!**

The front mounting must not be used when installing load compartment grille. Use rear mounting!

**Caution!**

Be extra careful when removing or installing this component.

**Caution!**

Make sure not to damage painted surfaces.

The work may only be performed by trained personnel and at an approved location for this type of work.

---

## Color symbols

---



# Installation instructions, accessories

Volvo Car Corporation Gothenburg, Sweden

3

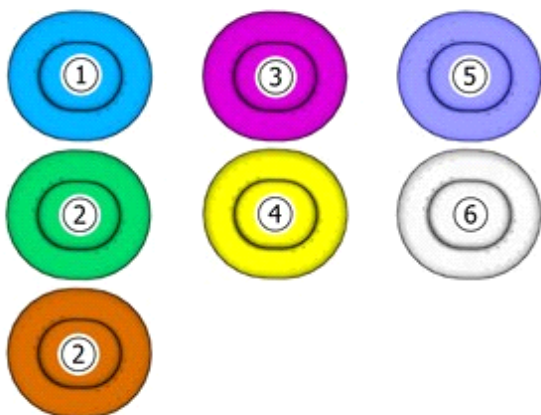

IMG-363036

## Note!

This colour chart displays (in colour print and electronic version) the importance of the different colours used in the images of the method steps.

- Used for focused component, the component with which you will do something.
- Used as extra colors when you need to show or differentiate additional parts.
- Used for attachments that are to be removed/installed. May be screws, clips, connectors, etc.
- Used when the component is not fully removed from the vehicle but only hung to the side.
- Used for standard tools and special tools.
- Used as background color for vehicle components.

---

## Preparation

---

4

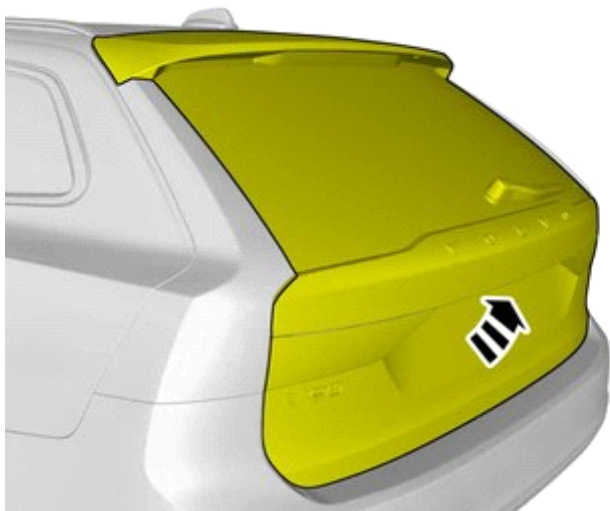

IMG-407110



# Installation instructions, accessories

Volvo Car Corporation Gothenburg, Sweden

5

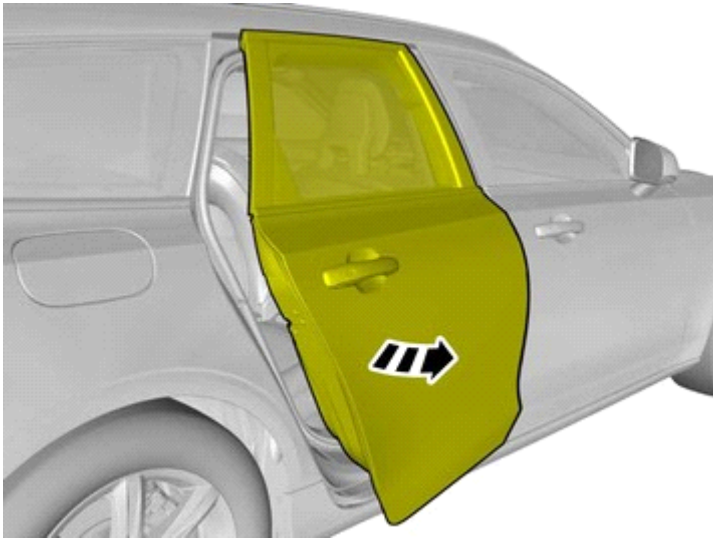

IMG-415787

Repeat on the other side.

6



IMG-411070

**Removal**



# Installation instructions, accessories

Volvo Car Corporation Gothenburg, Sweden

7

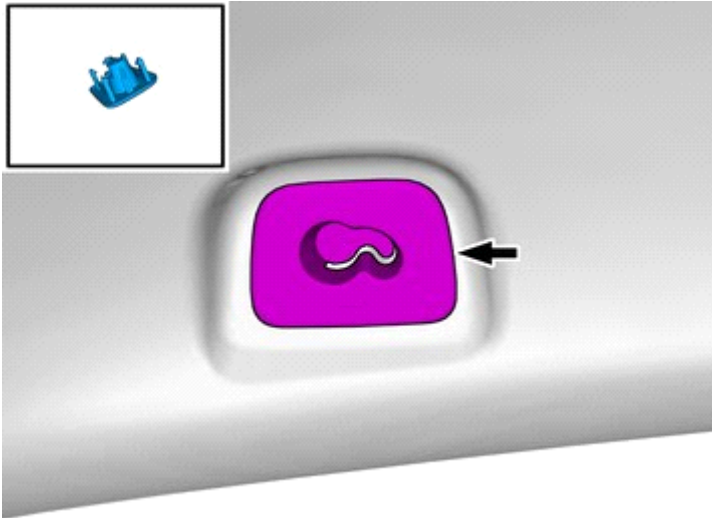

IMG-423866

Remove the marked part.

Repeat on the other side.

---

## Accessory installation

8

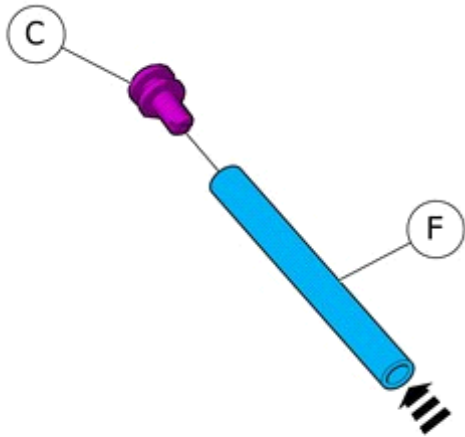

IMG-424110

Place the component where indicated in the graphic.



# Installation instructions, accessories

Volvo Car Corporation Gothenburg, Sweden

9

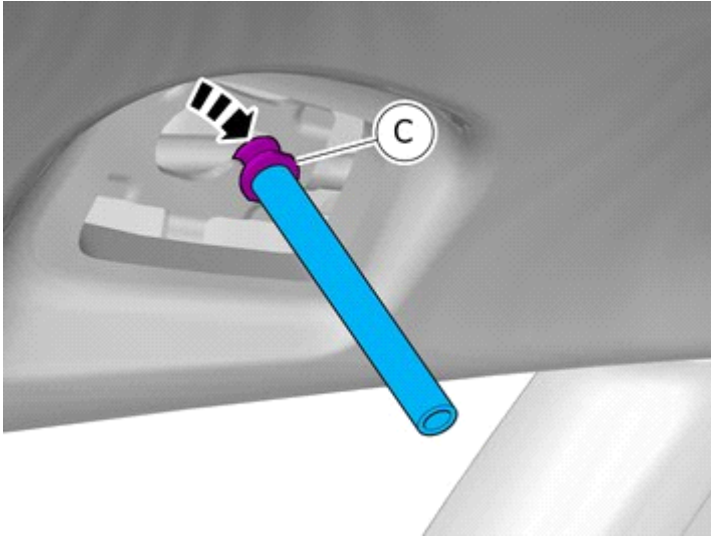

IMG-424111

Install component that comes with the accessory kit.

10

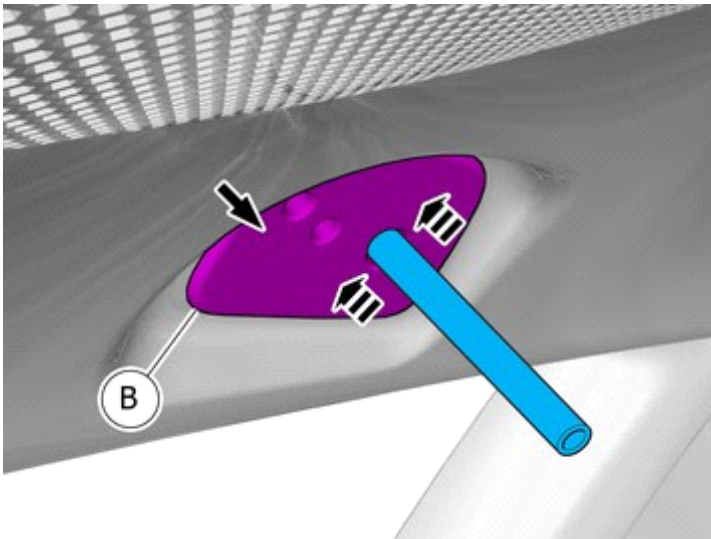

IMG-424112

Install component that comes with the accessory kit.

11

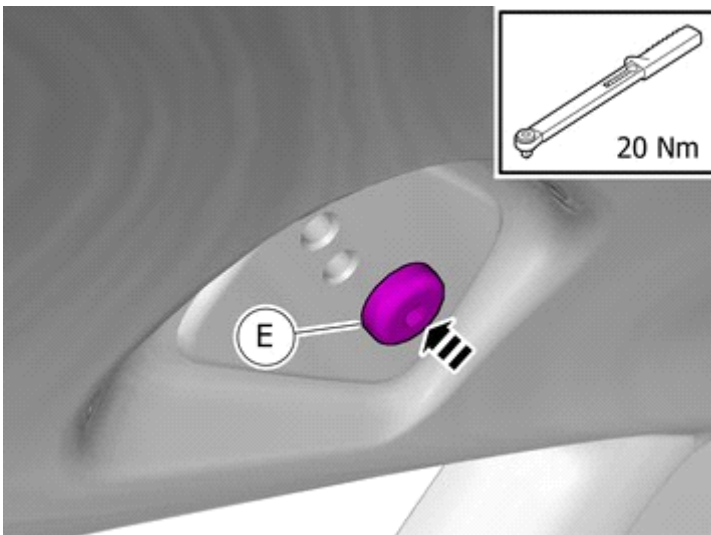

IMG-424113

Install component that comes with the accessory kit.

Use hands only.



# Installation instructions, accessories

Volvo Car Corporation Gothenburg, Sweden

12

Repeat all method steps for the other side.

13

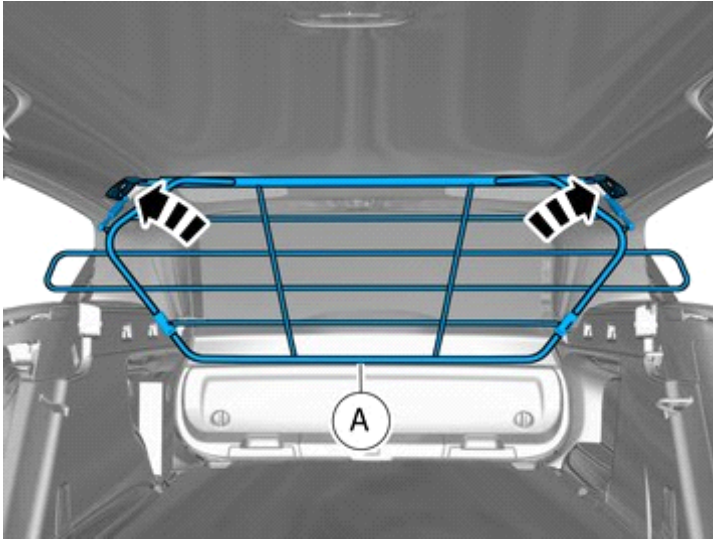

IMG-424126

Install component that comes with the accessory kit.

14

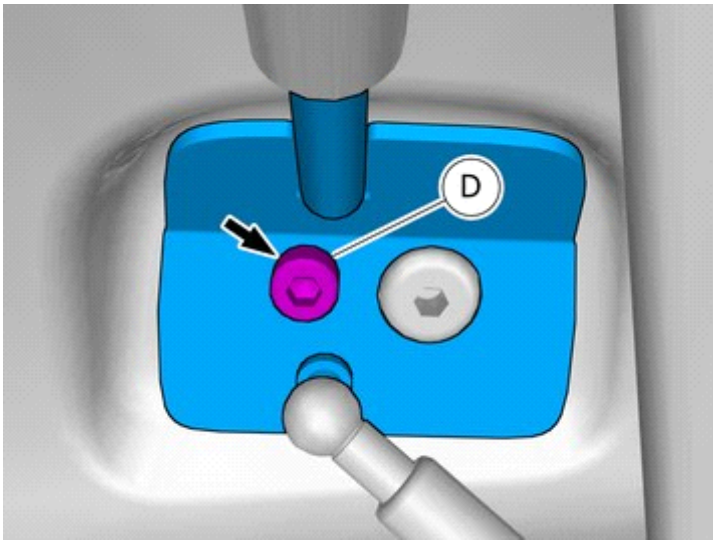

IMG-425587

Install component that comes with the accessory kit.

Repeat on the other side.

Use hands only.





# Installation instructions, accessories

Volvo Car Corporation Gothenburg, Sweden

15

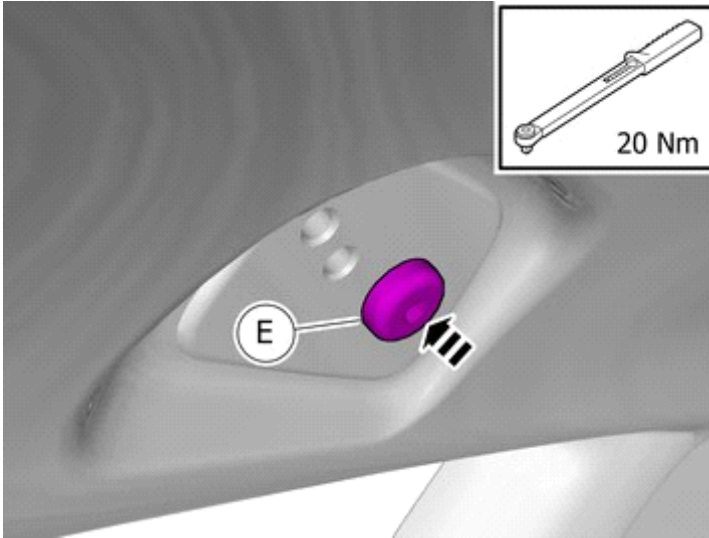

IMG-424113

Tighten the screw.

**Tightening torque:** M8 , 24 Nm

Repeat on the other side.

16

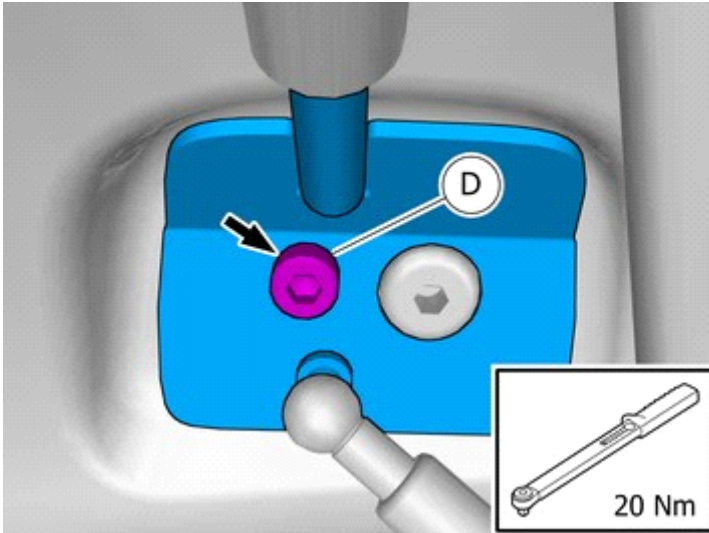

IMG-424127

Tighten the screw.

Repeat on the other side.